

# MICEDD

## DEEPWATER DEVELOPMENT

28 - 30 March 2023 | Millennium Gloucester Hotel | London, UK

ORGANIZED BY



Quest Offshore

World Oil®

# A Real-Time Fatigue Monitoring Platform for Flexible Pipes

Eric Wilson  
Baker Hughes

# Outline

1. Introduction
2. Methodology Background
3. Fatigue Analysis Procedure
4. Condition Monitoring Platform
5. Demo

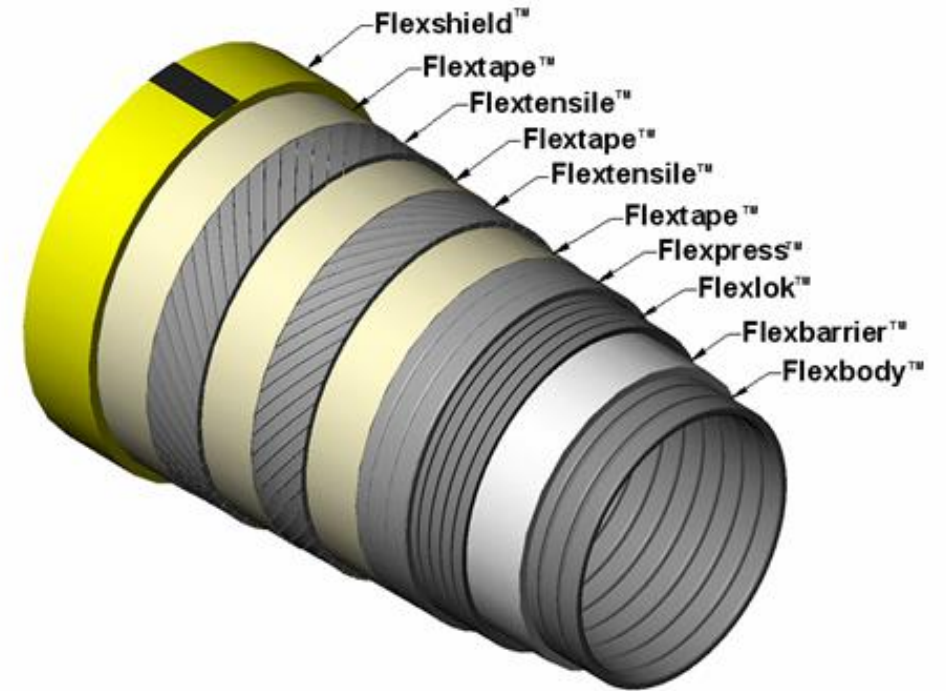

# 1 Introduction

- Fatigue life of tensile wires is a critical design factor in flexible pipe design and riser system configuration. Traditionally, global and local fatigue assessment were performed based on given environment, vessel and riser data. Load case matrix is pre-defined from clients' metocean report. The riser configuration is modelled in commercial software like "OrcaFlex" or "Flexcomm3D". By running dynamic simulation, global responses of riser were calculated by the software and converted into local stresses based on in-house software. The fatigue damage is then calculated with defined S-N curves and cycle numbers for each load case.



# 1 Introduction

The traditional fatigue analysis is based on:

- Pre-defined Load Case Matrix
- Assumed Vessel/Platform draught and offsets
- Assumed Riser Operating Conditions (pressure, temperature, contents)

In addition, an API safety factor of 10 is implemented in the fatigue life requirement.

The estimated fatigue damage from the design stage might be very conservative comparing to the actual fatigue damage of flexible risers in the field.

# 1 Introduction

## Baker Hughes

- Developed a special software tool to calculate the real time fatigue
- Based on product design tools
- Calibrated and independently validated with over 30 years installed operational experience.
- Is customized towards different platforms and riser systems, as well as input data types.
- Multiple fatigue hot spots like top end fitting, bend stiffener region or touch down zone can be monitored at the same time.
- Other parameters like riser real time extreme response or statistical results can also be checked in the software.

# 2 Methodology

- Tensile Wire Stresses:

- Axial stress  $\sigma_a$  due to tension and pressure – Straight Pipe **FPS**
- Bending stress about the normal axis  $\sigma_{b_n}$
- Bending stress about the bi-normal axis  $\sigma_{b_b}$
- Friction stress  $\sigma_f$

} Bent Pipe **Torus**

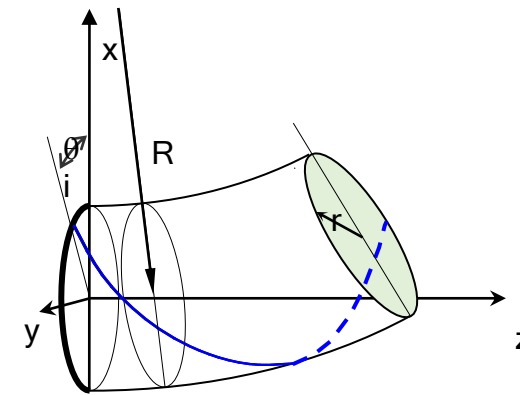
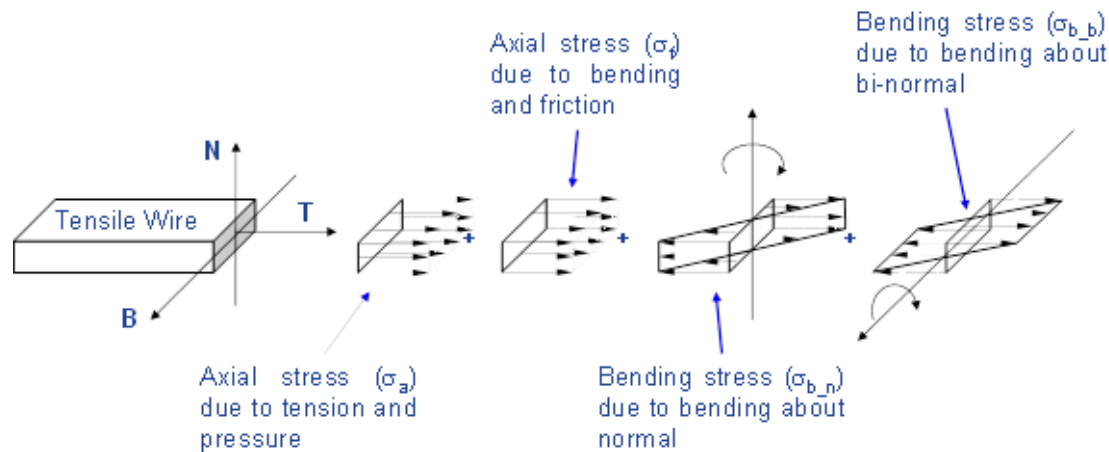

# 2 Methodology

BH Fatigue Analyses Methodology is developed in-house, and calibrated and validated against many full-scale dynamic tests covering existing product ranges and application water depths.

- Fully reviewed and approved by IVA (Lloyds Registry)
- Applied in riser system design over three decades
- Validated by the retired riser products after reaching the design life
- No field fatigue incident reported so far

BH Fatigue Analysis Methodology gives unique advantages for the real-time fatigue monitoring



# 2 Methodology

- Full friction bending model was implemented in OrcaFlex
- Interface with OrcaFlex during simulation, at each time steps
- Enable more accurate riser and tensile wire stress responses

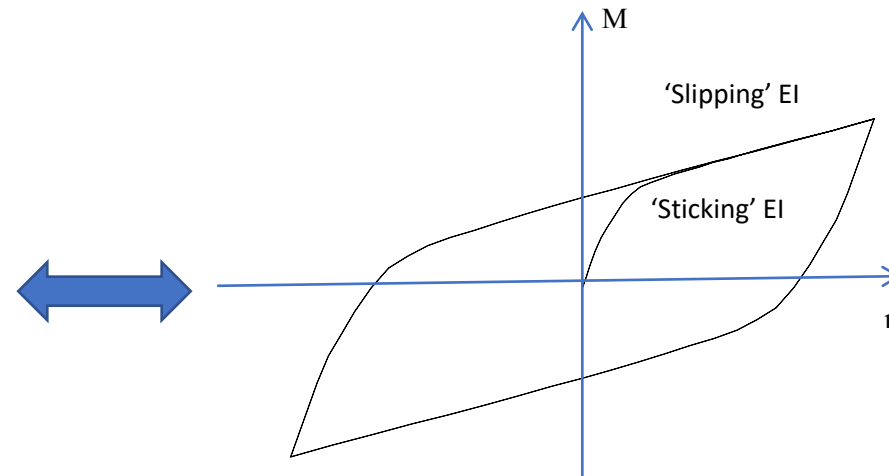
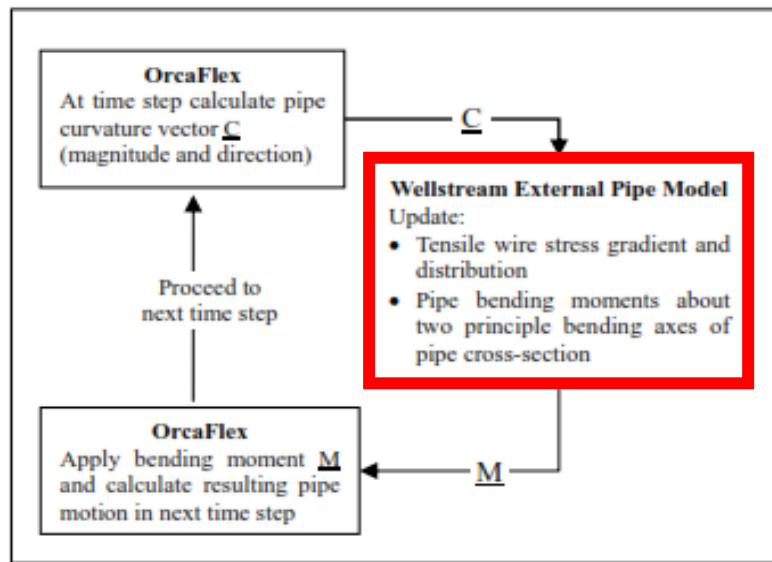

# 3 Fatigue Analysis Procedure

- The whole fatigue analysis is directly performed within OrcaFlex.

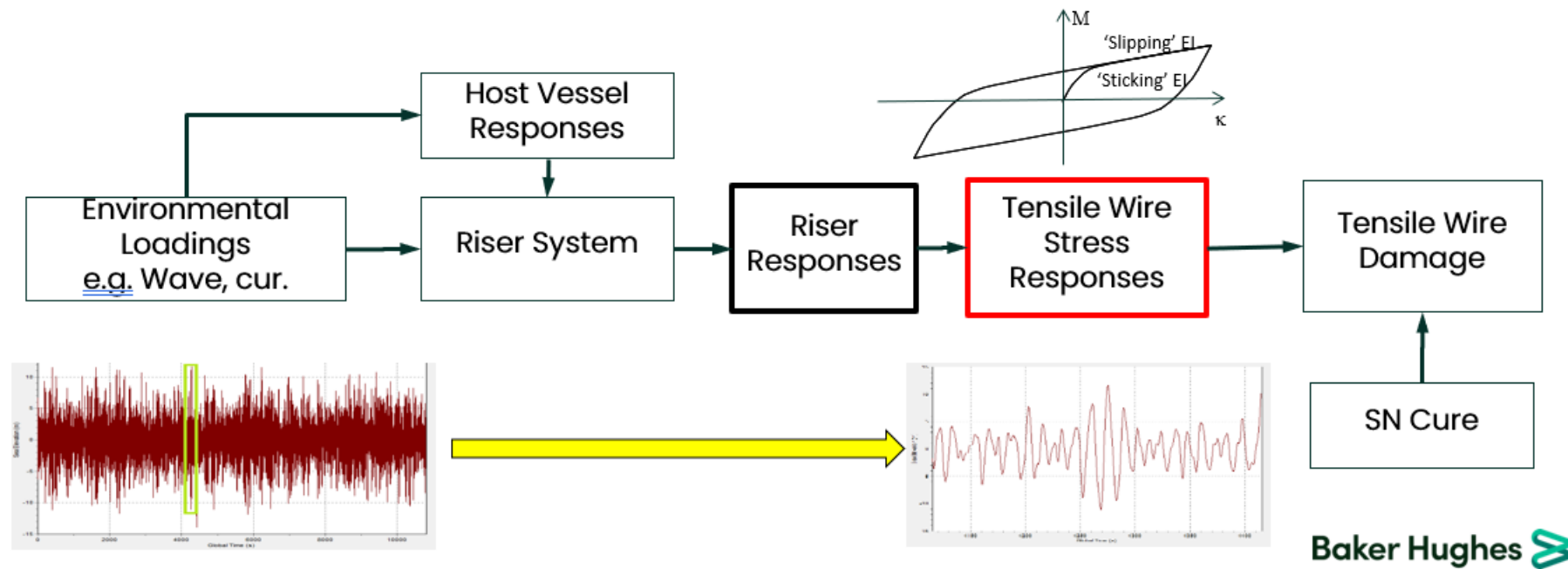

# 3 Fatigue Analysis Procedure

- **Dynamic bending and tension – Pipe Body**

- Top hang-off region with bending stiffener protection
- Hog/Sag bending region with buoyancy modulus
- Touch down zone

- **Dynamic tension only – End Fitting Tensile Wire Anchoring (for deep water)**

- Top end fitting
- Midline connections

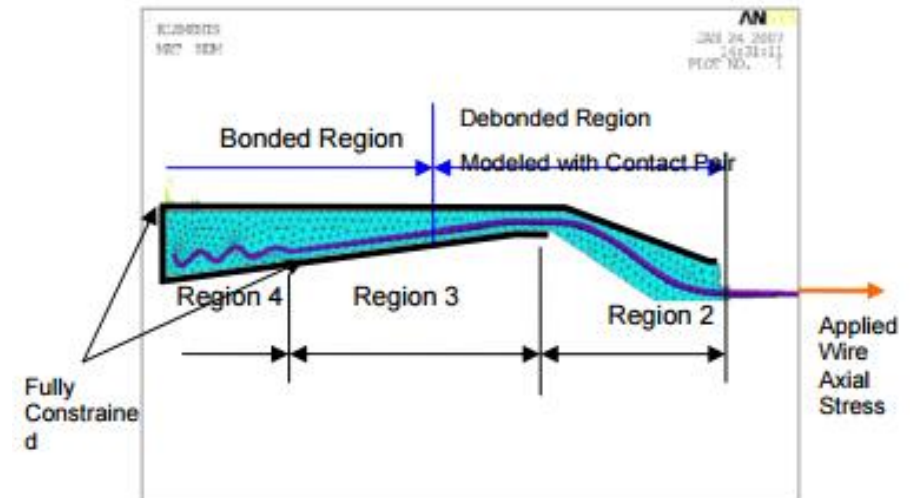
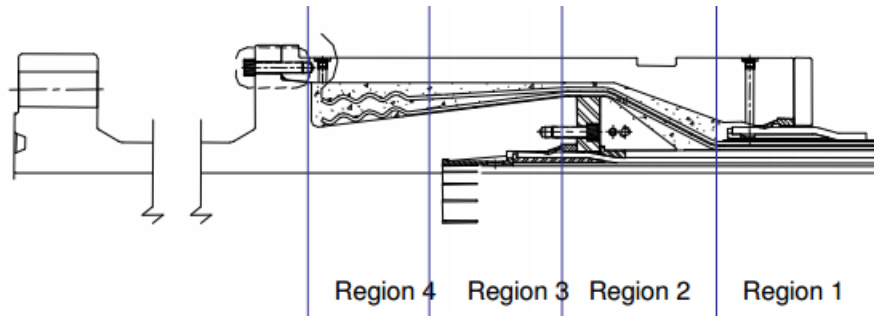
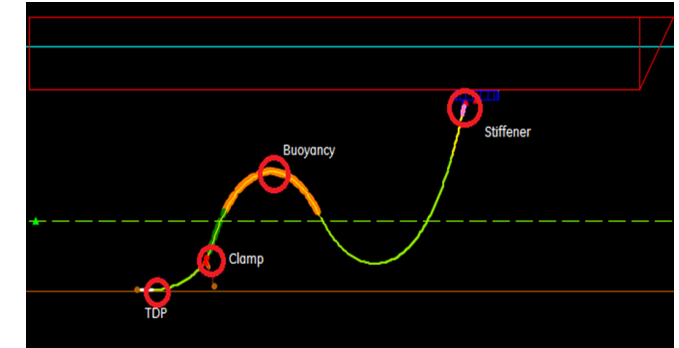

# 4 Condition Monitoring

- BH developed a tool with Python to enable field fatigue assessment and condition monitoring. This tool can be applied to existing and new field development:
  - 1) Requires model setup such as pipe design, vessel and seabed.
  - 2) Takes real-time inputs like vessel motion, operating conditions.
  - 3) Calculates tensile stress, damage and riser responses.
  - 4) Fatigue results are plotted in software and stored both locally and in server.

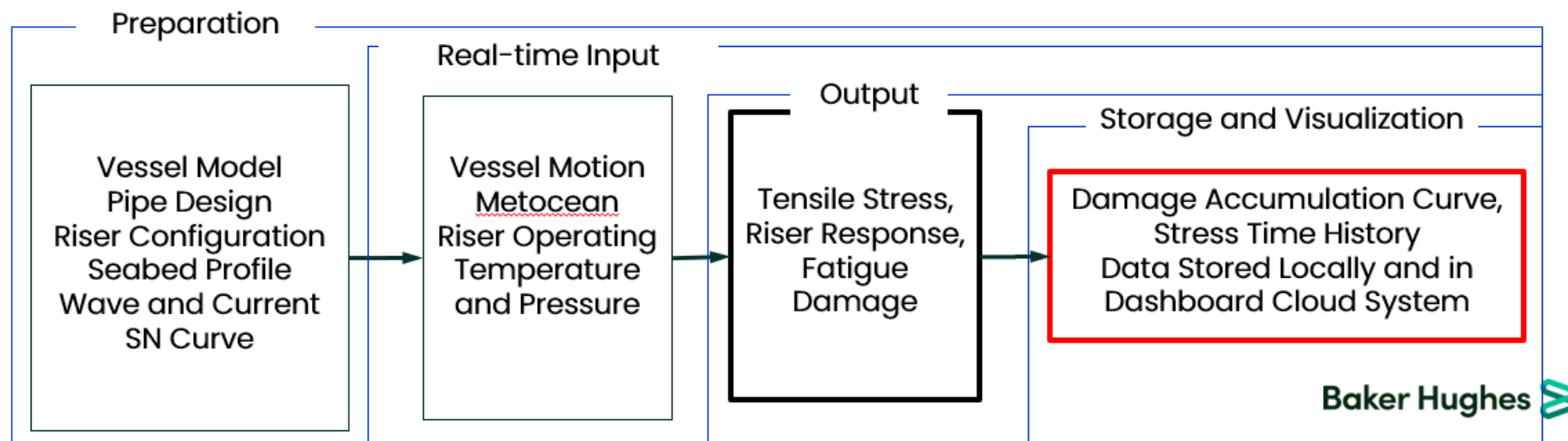

# 4 Condition Monitoring

Improved accuracy and efficiency by field monitoring data, For Example:

- 1) Wire stress monitoring to Fatigue damage – **SN Curve**
- 2) Riser Responses to Fatigue damage – **Local Structural Model**
- 3) Vessel Motion to Fatigue damage – **OrcaFlex & Local Models**
- 4) Wave & Current to Fatigue damage – **OrcaFlex & Local Models**

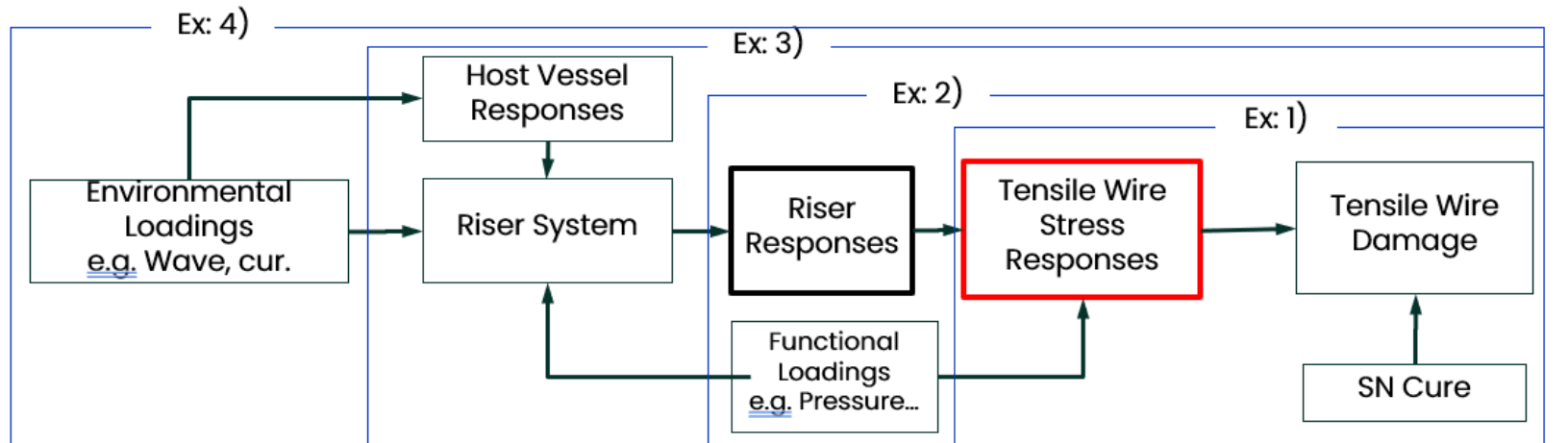
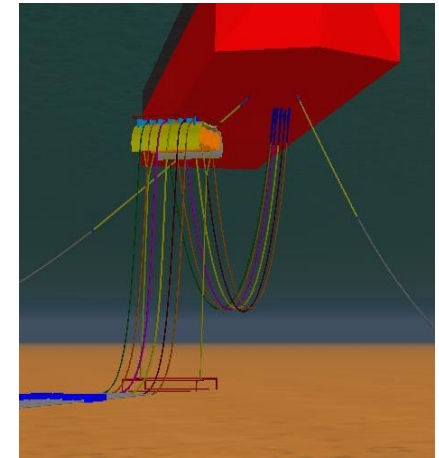

*A customized process to fit client requirements!*

Baker Hughes 

# 5 Demo

The user graphic interface is shown below.

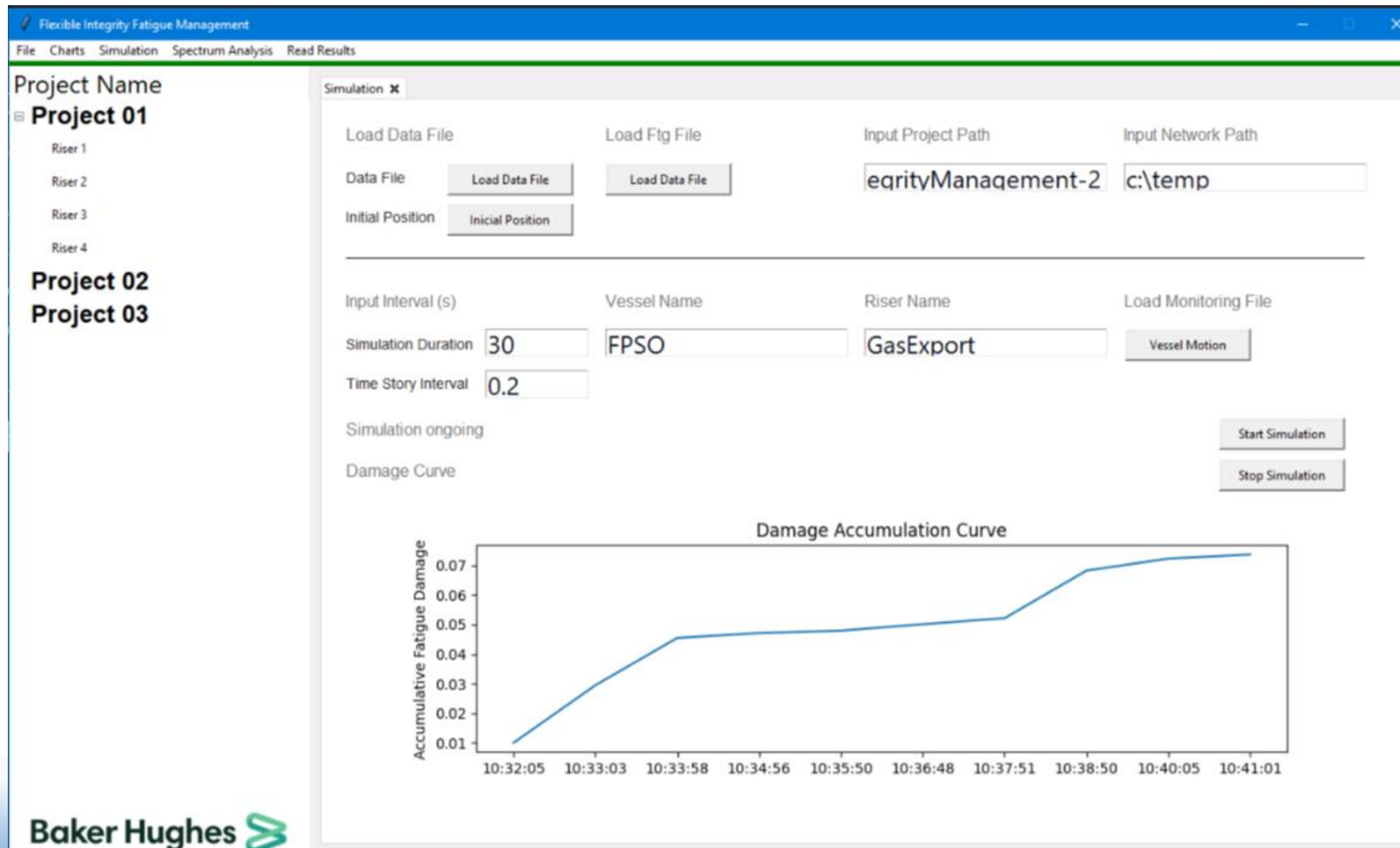

# 5 Demo

- A demo is shown here based on real field measurement of vessel motion. The project has recorded time history of 6D vessel motions. The motions are treated as real-time inputs for the software to calculate fatigue damage.

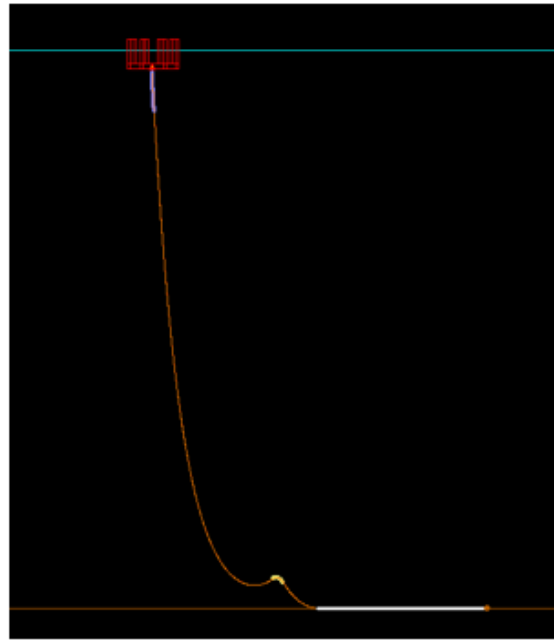

Parameter	Project
Water Depth (m)	980
Configuration	Lazy Wave
Pipe ID (inch)	6"
Floater	Semi
Region	Brazil

# 5 Demo

- Realtime FPSO 6D motions are used as inputs for the FEA analysis.

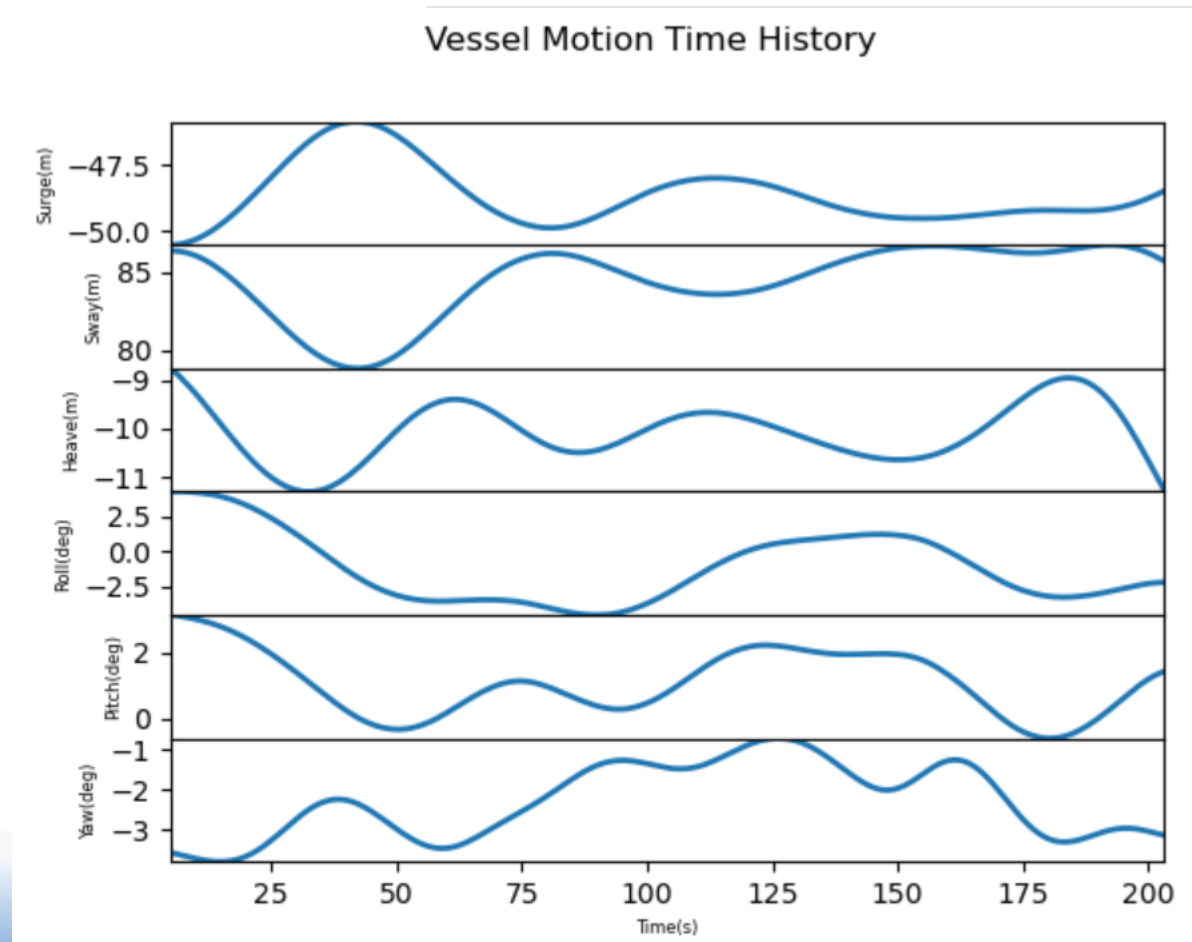



# 5 Demo

- The stiffener region is being “monitored”. Below is the illustration of damage accumulation curve at the worst location.

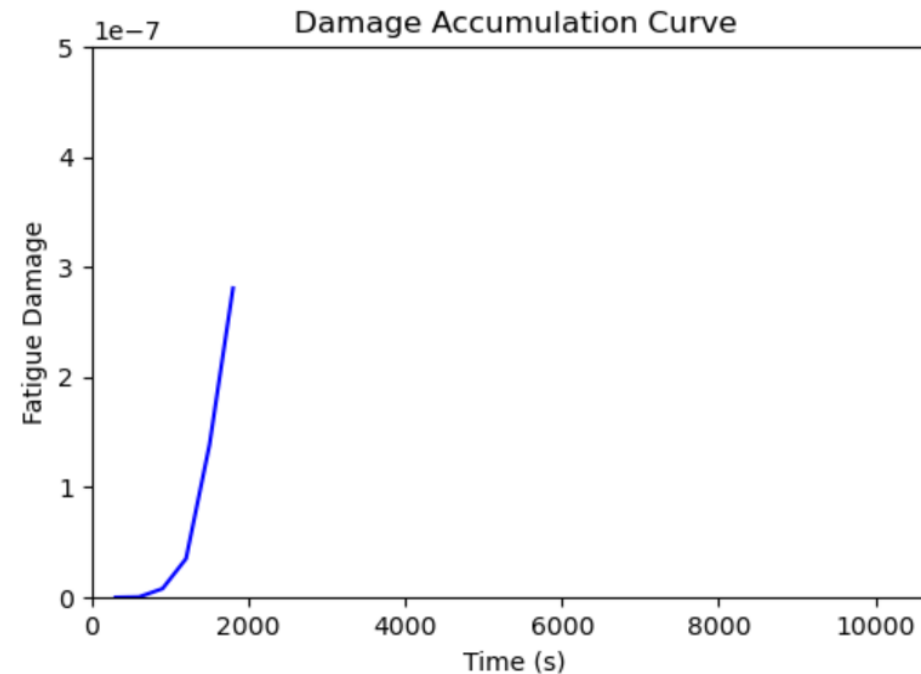

# 5 Demo

- Additionally, the damage distribution at different locations can be visualized.

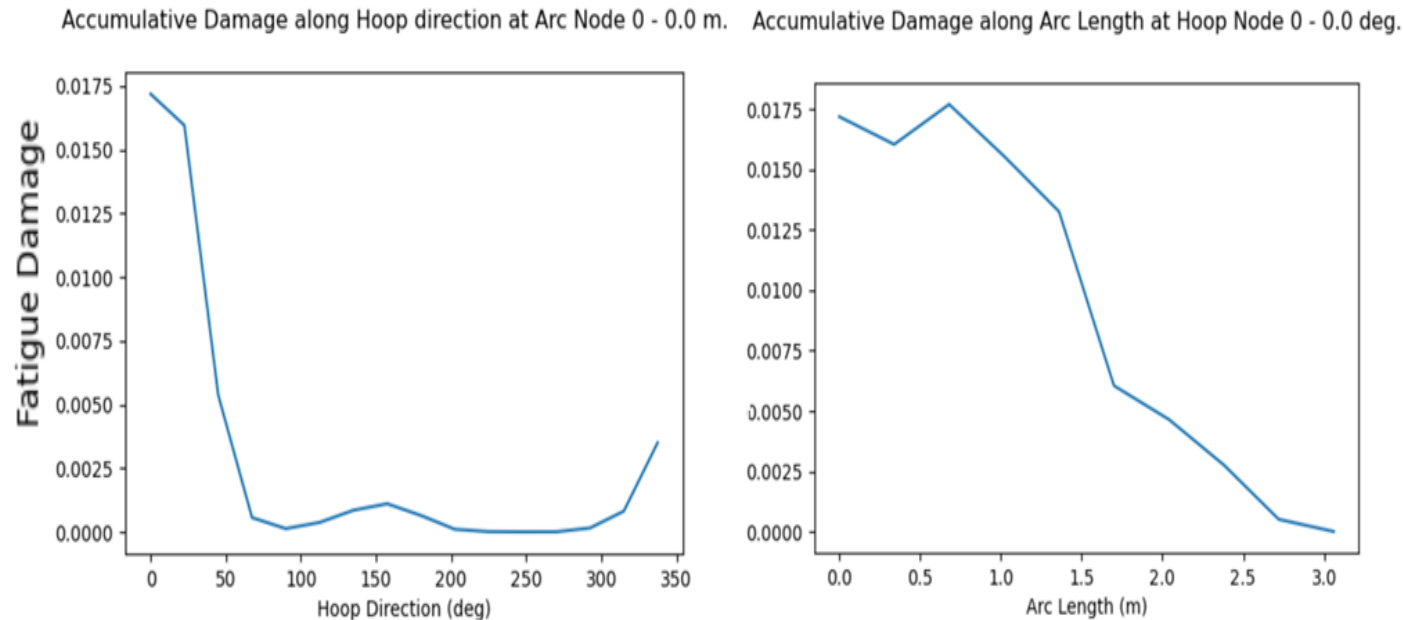

# 5 Demo

- The damage distribution at different locations can be visualized (both in hoop direction and arc length).

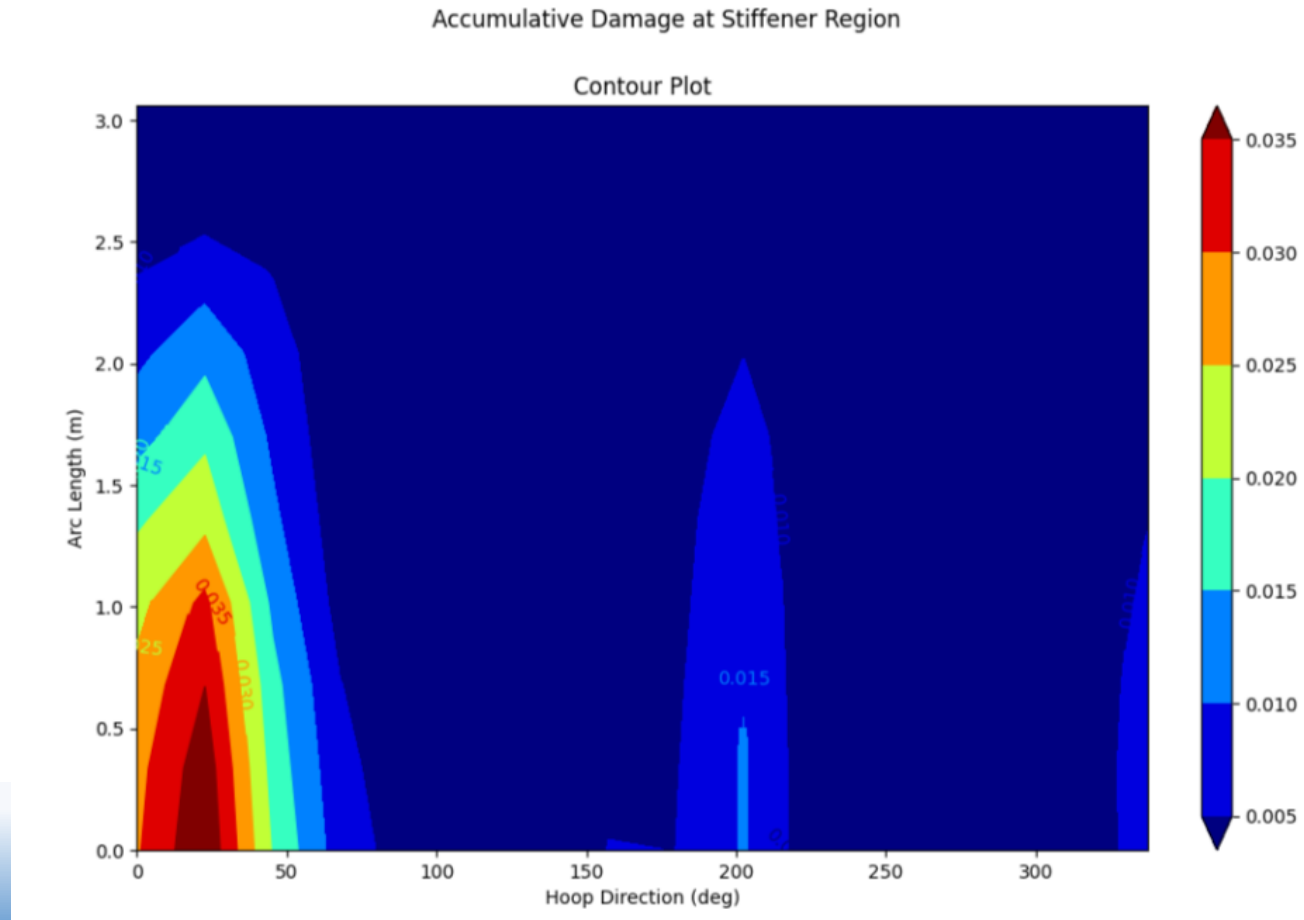

# 5 Demo

- Additionally, riser dynamic responses can be monitored and visualized in both time and spectral domains (Top Tension as an example).

Top Tension History

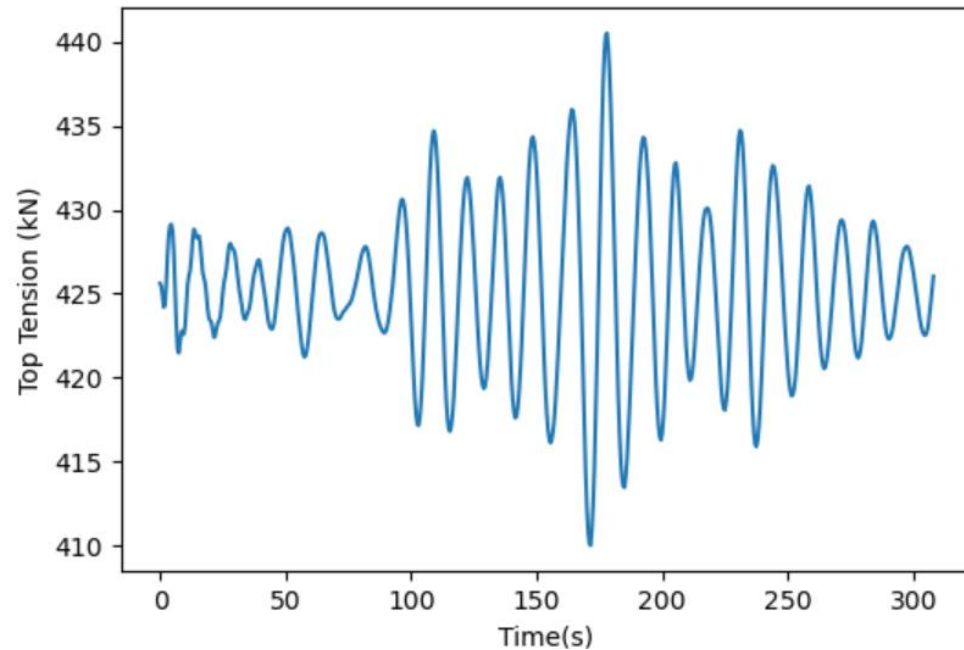

EndA Tension Spectrum for Riser:GasExport

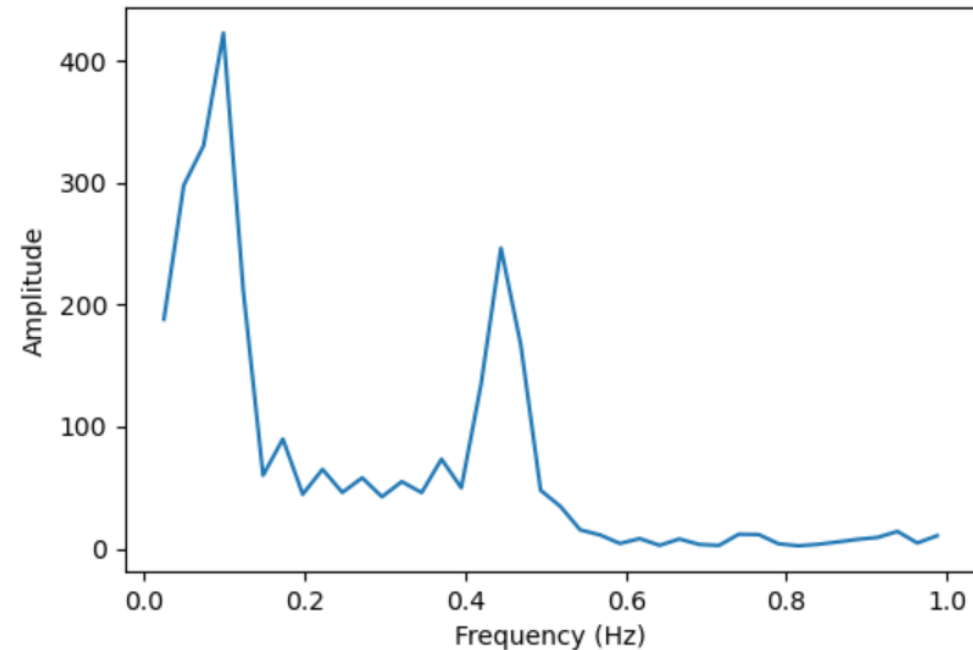

# Conclusion

- Baker Hughes developed a product to perform condition monitoring of the fatigue damage of flexible tensile wires during operation.
- Comparing to traditional inhouse fatigue analysis, the condition monitoring platform will produce more accurate fatigue damage for tensile layers, given that the sensor data are reliable field observation than the assumptions in traditional fatigue assessment.
- The software can take several different input data and is highly customizable for each field development. Fatigue damage of multiple locations of risers can be accessed simultaneously.
- With the field damage accumulation curve, operators will have more knowledge about the condition of their flexible risers.

# MICEDD

## DEEPWATER DEVELOPMENT

28 - 30 March 2023 | Millennium Gloucester Hotel | London, UK

ORGANIZED BY



Quest Offshore

World Oil®